

OWNER'S ENGINE MANUAL

BERKELEY PUMP COMPANY

ENJOY YOUR BERKELEY PACKAJET!

Congratulations on your choice of marine power! We are sure that the excellent performance and economical operation of your Packajet will justify the confidence you placed in Berkeley Pump Company when purchasing this unit.

This manual sets out in full, the data necessary for the proper operation, care and general maintenance of your unit. In addition, specifications have been included to familiarize you with the construction and mechanical details of this fine piece of equipment.

No effort has been spared to produce an efficient and reliable marine propulsion package. The Berkeley Packajet engine has been run and tested at our factory to assure proper operation of the lubrication, cooling, fuel and charging systems as well as the overall operating condition of the engine. This manual can help you obtain lasting satisfaction in the operation of your Packajet.

In order to obtain maximum enjoyment from your boat, we particularly stress the importance of following the recommendations set forth in this manual. The intimate knowledge obtained by studying this manual will assure you of the utmost service and satisfaction.

Experienced boat owners know the value of preventive maintenance. Your efforts in regard to care and maintenance will be amply rewarded in the long run.

INDEX

SECTION	SUBJECT	PAGE
I	GENERAL INFORMATION	3
II	OPERATION	3
III	INSTRUMENTS	7
IV	MAINTENANCE	8
V	TUNE-UP	12
VI	TROUBLE SHOOTING	14
VII	TECHNICAL DATA	15

Marine engines used with Berkeley Jet-Drives are mounted low in the hull. Certain precautions are usually taken by engine manufacturers to prevent damage to the engine from the injection of water into the cylinders which could cause a hydrostatic lock. This hydraulic condition can cause bent valves, rods and block damage. Boat manufacturers include several means of protection against this but no mechanical system can entirely prevent it without careful operation as described in the following paragraphs.

Exhaust risers are located at the aft end of the exhaust manifolds and provide a dam between the engine and the open water. They should not be replaced by any other type outlets.

Exhaust ports should include a flapper valve on the outside of the port to help prevent surges from entering the exhaust manifold. These should not be removed and if damaged from operation, should be replaced immediately.

These precautionary measures should be taken during operation.

1. Decelerate slowly to prevent the build-up of water surges against the transom of the boat.
2. After high speed running, idle the engine for a short time to cool the engine before turn off. This can help prevent pre-ignition which can cause an engine to kick back.
3. Carry only the recommended load in the boat. An overloaded boat causes the engine to be operated too far below the water line.
4. If the boat is beached, turn the bow to passing wakes to prevent surges against the transom.
5. In the event of a sudden stop, keep the engine running to keep exhaust water running out under circulating pump pressure. Leave engine running and boat in neutral until the wake subsides.
6. A heavy duty starter is capable of bending rods if forced to turn the engine against water in the cylinders. If resistance to normal cranking is evident, remove all spark plugs and crank the engine for approximately 10 seconds. This should remove all cylinder water. Dry and replace plugs and restart.
7. When retrieving the boat from the water, elevate the bow to drain all water from the exhaust system.
8. When flushing the engine, elevate the bow to allow all water to drain from the exhaust system.

BERKELEY 455 PACKAJET

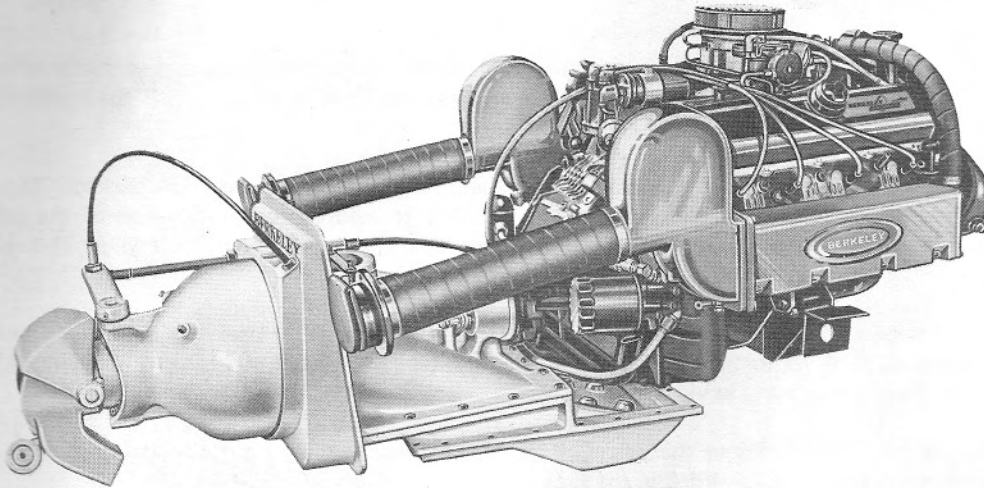

ONE YEAR LIMITED WARRANTY

The following warranty has been drafted to comply with the Magnuson-Moss Consumer Products Warranties Law applicable to products manufactured after July 14, 1975. This warranty, in no manner, reduces the coverage provided to you under the warranty it replaces.

The Berkeley Jet-Drive and Packajet is covered by a LIMITED WARRANTY of 12 months (in commercial service, 3 months) dating from either the date of first being placed in service (such as a demonstrator or other use) or the date of sale to the original retail purchaser, whichever is first. Any implied warranties will be limited to these same periods of time.

For the periods described above, any unit or part returned to Berkeley Pump Company by any registered dealer or boat manufacturer which, upon examination, is found defective will be replaced. Labor involved will be reimbursed according to the "Berkeley Labor Rate Schedule" as shown in our Marine Catalog.

Claims to be honored through this warranty shall be processed upon presentation to Berkeley Pump Company of a completed "Warranty Allowance Request," Form 518R, available through our registered dealers and boat manufacturers. A warranty claim cannot be processed without receipt of the "Warranty Register Card," Form 444-R2.

Berkeley Pump Company reserves the right to make changes or improvements in its products without imposing any obligations on the Company to install them on products previously manufactured.

We make no warranty with respect to trade accessories. They are subject to the warranties of their manufacturers.

What is NOT covered by the warranty:

- (1) Adjustment or replacement of maintenance items, such as, but not limited to, ignition parts, or carburetion, filters and lubrication systems or controls.
- (2) Any service work performed to correct malfunctions caused by misuse, negligence or disregard for our written instructions concerning installation, operation and maintenance.
- (3) Additional service work performed above that which is required to satisfy warranty requirements.
- (4) Transportation charges, haul out, travel time, loss of use or other consequential charge or extra charge for hull service occasioned by hull design.
- (5) Units or parts damaged by salt water corrosion, racing or experimental work, or by operation with parts not approved by Berkeley, or for other reasons beyond the control of Berkeley Pump Company.

Owner's Obligations:

- (1) The warranty register card (pre-addressed and postage paid) must be mailed within one week after delivery to the retail purchaser of the boat in which Berkeley marine equipment is installed.
- (2) Proper break-in, operation and maintenance instructions must be followed. These are available from Berkeley Pump Company, in case they are not available to the boat owner at the time of purchase.
- (3) Possible warranty situations must be brought to the attention of Berkeley Pump Company or the registered dealer as they may arise. Severe owner responsibility damage may result from inattention to minor problems. At the first sign of possible trouble, the boat should be returned to the dealer from which it was purchased. Parts required by a registered dealer should be available for return to Berkeley Pump Company to determine warranty.

I. GENERAL INFORMATION

A. REGISTRATION Included with this manual is a Warranty Register card which must be filled out and mailed to validate the warranty on this engine. This card is postage paid and pre-addressed and must be mailed within one week of purchase date.

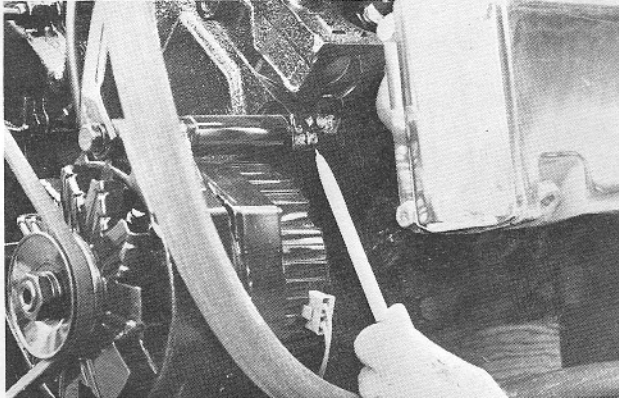

Figure 1

The Berkeley serial number is found on the oval data plate attached to the bell housing as shown in Fig. 2. Please refer to this serial number in any correspondence with Berkeley concerning this engine.

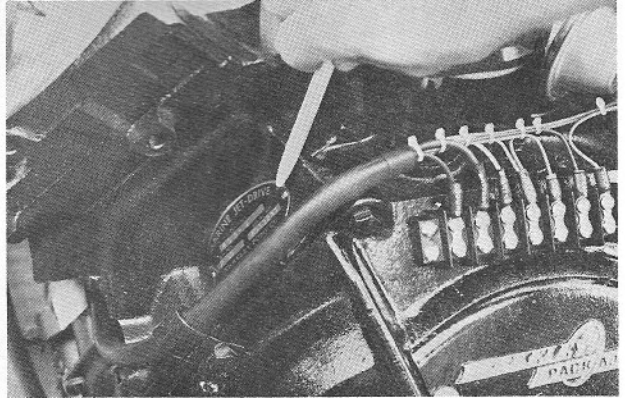

Figure 2

II. OPERATION

Sound engineering practices, precision manufacturing techniques and a disciplined testing program have been coordinated to achieve flawless operation of your Packajet 455. Attention to the following topics plus a minimum of effort where required will complete the picture of years of trouble-free service.

A. COOLING SYSTEM This system is a thermostatically controlled make-up type circulating system (Figure 3). Water is continuously circulated throughout the engine by a low pressure, high capacity automotive pump. An excess flow of cool water under minimal pressure is always available to the system from the Jet-Drive. The pressure-balanced thermostat opens as the engine reaches operating temperature and hot water leaves the system, allowing cool water to replace it. The volume of hot water which is replaced by cool water is controlled by the amount of thermostat opening. Thus a constant operating temperature is maintained under any condition, whether idling for long periods of time or running wide open.

In addition to the volume control provided by the thermostat, directional control of inlet and outlet water is afforded by the water manifold which sits atop the thermostat housing. The water manifold initially directs most of the supply water to the circulating pump for filling the engine's water passages and it diverts excess water directly to the exhaust manifolds and high rise elbows (risers), which are cooled in a single pass. (Water enters at the front of the exhaust manifolds and passes once through the manifolds and risers.) From this point the water enters the exhaust stream and exits the boat. Since some cool water is always supplied to the exhaust manifolds and risers, they

will always run cool. Also, no pressure build-up from the supply pump (Jet-Drive) occurs in the water manifold, because the hoses, exhaust manifolds and risers have adequate size water passages. Water which does not exit the engine through the thermostat is recirculated to the engine's water pump with no restriction to flow offered by the thermostat, which is in parallel with the path of recirculating flow. This water then mixes in the water pump with the cool incoming water added to the system and its temperature is reduced before re-entering the engine. Since the primary direction of flow within the water manifold is to the circulating pump, a continuous re-supply (or make-up) of cooling water is always assured.

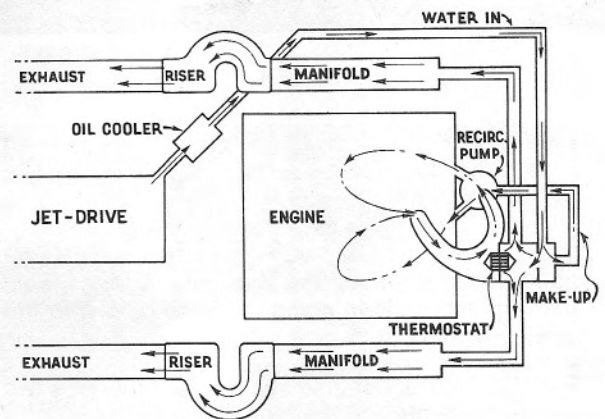

Figure 3

Uniform cylinder head and block temperatures are maintained at all times. Since the thermostat is vented, air pockets are not created as the engine fills with water, thus eliminating "hot spots" in the engine which arise from the presence of trapped, vaporized water. The continuous water circulation causes a "scrubbing" action of the water jacket walls, thereby alleviating the possibility of vapor pocket formation during operation.

When the engine is turned off, cooling water does not drain from the engine. Since both the water manifold and risers are at approximately the same height, no syphoning effect can occur to drain the engine. Consequently, the cooling water remains to absorb residual heat build-up within the engine after shut-down and also minimizes corrosion.

The risers are designed to provide a wall between the water outside the boat and the engine exhaust ports so the water will not run into the engine. These walls are meant to be several inches above the load waterline of the boat to protect against water surging and wave-action. After the wall the engine cooling water is discharged into the exhaust gas to cool and muffle the noise before discharging overboard.

As a final safeguard exhaust flaps are installed over the exhaust exit to prevent stern waves from surging into the exhaust and going over the wall to the engine exhaust ports. The flaps are not tight enough to be water seals. Be sure never to let the waterline of the boat be any higher than within four inches of the top of the risers. Too many people in the after end of the boat when it is not operating might do this.

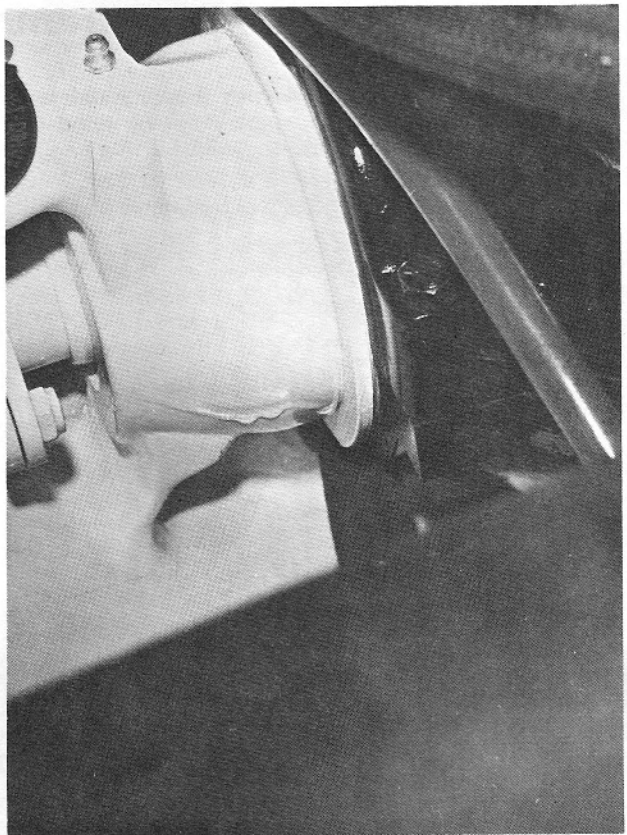

Figure 5

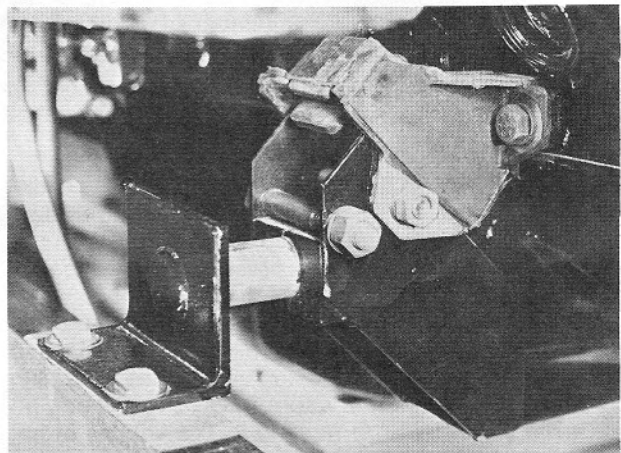

Figure 6

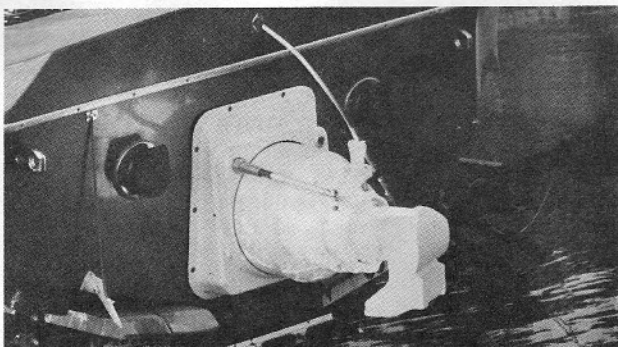

Figure 4

B. ENGINE MOUNTING The Berkeley three-point mounting system has several distinct advantages over the standard four-point system. Of these the alignment feature is the most important. A mounting fixture is available from Berkeley Pump Company which positions the front engine mounts so that the engine is in complete alignment with the Jet-Drive shaft.

Further, the front engine support incorporates two resilient mounts and the rear of the engine clamps to a resilient ring on the bearing cap of the Jet-Drive (Figures 5, 6). In this way the life of the splined coupling connecting the engine to the Jet-Drive is greatly prolonged, and unwanted vibration is reduced to a minimum.

One of the advantages of the Berkeley Jet-Drive installation is that the engine is mounted lower in the boat hull than with Vee drive or I/O and this makes for lower silhouette and better boat balance. When the jet and engine are properly installed, there should be approximately 1/4" clearance between the lowest part of the engine oil pan and the Jet-Drive intake adapter. To prevent any possibility of interference between the intake adapter bolts or machine screws and the engine oil pan, these bolts or screws should have been cut off flush with the nuts during boat assembly. Check for clearance before operation of the boat.

C. FUEL DESIGNATION The required fuel for Berkeley Packajet 455-3 and 455-4 (low compression) engines is leaded regular or low-lead regular gasoline. The minimum research octane number (R. O. N.) is 91.

The required fuel for Berkeley Packajet 455-2 (high compression) is premium fuel only. The minimum research octane number (R. O. N.) is 99.

The anti-knock quality of all fuels, though they may be of equivalent octane rating, is not the same. Use of a fuel which is too low in anti-knock quality will result in a "spark-knock." Spark-knock can also be caused by such factors as combustion chamber deposits or incorrect spark advance or spark plug heat range. It can be described as a metallic rapping noise, resulting from uneven burning during the combustion process. Spark-knock will cause damage to the engine sub-assembly and constitutes misuse of the engine sub-assembly for which Berkeley Pump Company is not responsible.

The best protection against spark-knock is use of the recommended grade of fuel and adherence to basic tune-up specifications. However, should spark-knock be heard at any time, reduce power until it is eliminated. If spark-knock persists after a change of fuel, report it to your dealer at the earliest possible opportunity.

D. ELECTRICAL REQUIREMENTS A Delco Model R71-S battery or its equivalent is recommended. This is a 74 Ampere-hour, 90 plate battery. Positive and negative battery cables should be no smaller than No. 1 gauge if less than 24 inches in length, and no smaller than "O" gauge if longer than this amount.

E. PRE-OPERATION CHECK Prior to operation it is highly recommended that certain checks be performed. Lasting satisfaction is the goal; with a little preventive medicine in the initial hours of your engine's operation, the life of the engine is increased. Further, the possibility of operating problems "on the water" is greatly reduced.

PROPER OIL LEVEL The engine oil indicator or "dipstick" is located on the left side of the engine. There are two lines near the bottom of the dipstick, one being marked "FULL" while the other is marked "ADD". At no time should the oil level be higher than the "FULL" mark or lower than the "ADD" line.

SECURE FITTINGS AND CONNECTIONS All mounting bolts, fuel, lubrication, electrical and cooling system connections should be checked. As pointed out previously, your Packajet 455 has been run and thoroughly tested for proper operation at our plant prior to shipment. Nevertheless, make certain nothing was loosened during shipment.

STARTER AND UNIVERSAL JOINT LUBRICATION An oil hole has been provided in the lower left hand side of the engine bell housing to allow access to the starter gear and shaft for lubrication purposes (Figure 7). A light coat of engine oil will prevent any oxidation here which may be caused by the presence of water in the bilge area.

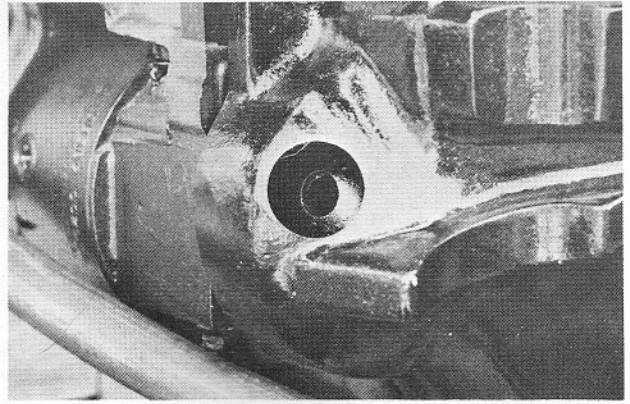

Figure 7

The bilge or lower engine compartment must be kept free of water. An electric bilge pump may have been provided by the boat builder or dealer and if not, one should be installed before operation. This should be operated before the engine is started if the boat has been in the water.

A Berkeley Jet Bailer can be installed to operate automatically during engine operation thereby keeping the bilge area completely dry. For this accessory, check with your dealer or contact the Factory.

Damage to a starter due to water is not covered by warranty.

Access to the splined coupling, or universal joint, which connects the engine's crankshaft and the Jet-Drive shaft is accomplished by removing the inspection plate on the top of the bell housing (Figure 8). A hand operated grease gun will supply sufficient lubrication pressure for each of the two grease fittings (one fitting on each "cross" of the coupling, Figure 9). Use multi-service automotive grease. However, at no time should the use of a high pressure lubrication gun be made. Note: The thrust bearing and the spline of the Jet-Drive receive lubrication through the grease fitting on the front of the Jet-Drive suction piece (Figure 10). Again, a hand operated grease gun should always be used. (See the Owner's Instruction Manual for the Jet-Drive unit for recommended water resisting greases.)

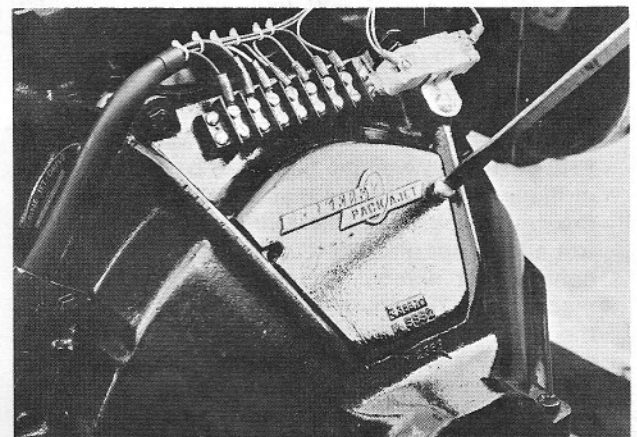

Figure 8

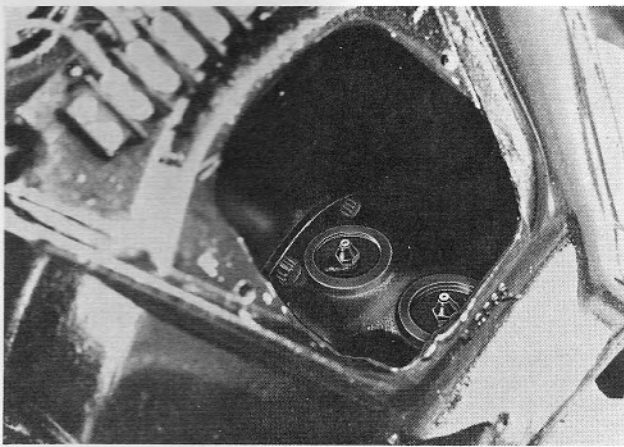

Figure 9

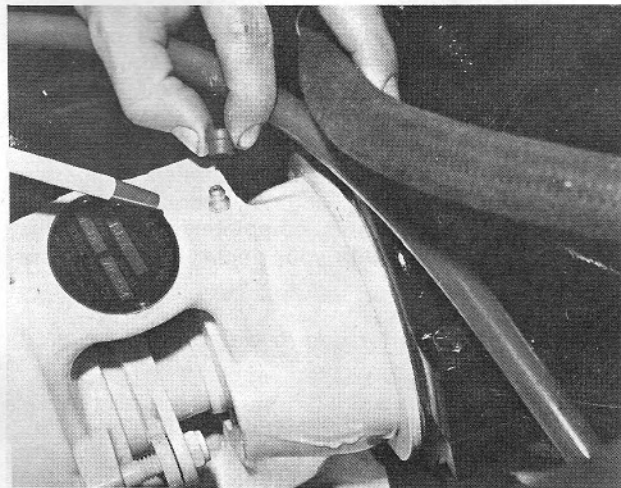

Figure 10-

F. STARTING Boats with an enclosed engine compartment are required to have a ventilation blower. This blower must be run for 5 minutes before starting the engine. Your Packajet 455 can be started while the boat is out of the water and run briefly provided that a sufficient water supply source is connected to the engine's inlet hose. Before starting the engine, fill the Jet-Drive bowl through the nozzle with as much water as possible. This will afford some lubrication between the Jet-Drive impeller and wear ring while running the engine with the boat out of the water. For safety reasons, the engine's carburetor and fuel pump are drained prior to shipment. Thus, when the engine is started for the first time, a certain amount of cranking to pump fuel to the carburetor may be necessary before the engine starts.

PROCEDURE When the boat is to be started while in the water, be certain that the shift control is in the neutral position. The Morse single-lever control allows operation of the throttle portion of the control unit without engaging the shift control mechanism. To use only the throttle control, place the selector lever in the neutral position and pull out the knob just behind the lever (Figure 11). The shift control mechanism is now disengaged. Where a foot control lever is employed, the forward-reverse control lever should be placed in such a position that the reverse bucket of the Jet-Drive is

open approximately $1\frac{5}{16}$ inches (measured when the bucket is pulled up tightly, applying maximum tension to the cable). This is the neutral position in which the control lever should always be placed during starting.

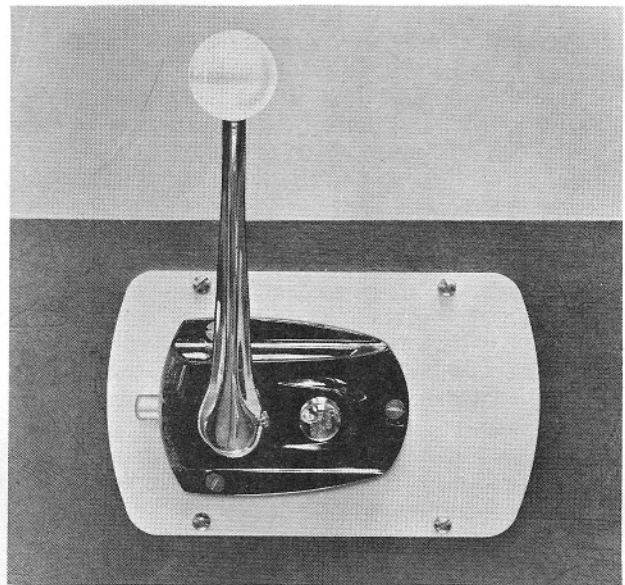

Figure 11

Depress the throttle fully and release or return it to the closed position. Crank the engine for no more than five seconds. If the engine fails to start, repeat this procedure until starting occurs.

As soon as the engine comes to life, the oil pressure gauge must be read to ensure that sufficient lubrication exists. The gauge should read no lower than 35 PSI when the engine is cold. Subsequently, the engine should be idled until near operating engine water temperature is reached.

Adhering to the following break-in schedule is another step which should be taken by you to provide further assurance of long life and top performance of your new 455 Packajet.

TIME	MAXIMUM RPM OPERATION
First Hour	Do not exceed 2000 RPM
Next 4 Hours	Do not exceed 3000 RPM
First 10 Hours	Do not operate at full throttle

CAUTION: If the engine is to be operated (after the initial break-in period) near or at the maximum RPM for extended periods of time, it is recommended that an RPM limiter device (rev. limiter) be installed on the engine to prevent a runaway condition (from the hull being temporarily airborne) which could seriously damage the engine or its components. The rev. limiter should be set at 5000 RPM.

Critical attention should be paid during this time to (1) engine oil level, (2) engine water temperature (during break-in it is extremely important that the engine not be allowed to overheat), and (3) the presence of any abnormal noise or vibration. The presence of water, oil or fuel leaks is a possibility and a visual check should be made for this.

III. INSTRUMENTS

The instruments in your boat are there for the purpose of informing you of the operation of your Packajet 455.

A. OIL PRESSURE GAUGE This is by far the most important gauge in the instrument panel. Though an engine can be damaged by overheating, disaster will strike much more rapidly due to a complete loss of oil pressure. Each time the boat is operated and at intermittent times during operation, this gauge should be read. Normal oil pressure is between 30 and 45 PSI at 1500 RPM.

B. WATER TEMPERATURE GAUGE Observation of this gauge is especially critical during break-in. Your Packajet 455 is equipped with a pressure balanced thermostat to regulate water temperature and keep it within a specific range best suited for the intended use of your boat. Periodic checks of this gauge during operation are a must to prevent overheating due to, for example, a clogged or restricted water passage. The gauge should be checked frequently during the first ten hours of operation and at lesser intervals after break-in. During warm-up observe the gauge periodically until temperature stabilizes within the specified operating range (see "Specifications"), thus indicating that the thermostat has opened and the total cooling system is operating properly.

C. TACHOMETER The tachometer, commonly referred to as the "tach", indicates engine speed in

revolutions per minute (RPM). As a preventive instrument it informs the driver of any adverse operating condition related to over-revving of the engine. It is also useful as a reference to operating speed when a speedometer is not employed as well as a necessary tune-up aid. Further, the tachometer can be used as an indicator of the engine's overall operating condition; any significant decrease in maximum engine speed during operation caused by a loss of power will be apparent in the tachometer reading.

D. VOLT METER The charging circuit of the electrical system is, as with all other systems, intended to operate within a certain range which is indicated on the volt meter. With the engine running, operation within the red region on the left of the dial (10V-11V) indicates a maximum alternator output caused by an extremely weak battery. The yellow region (11V-12V) again indicates a high charging rate but to a lesser degree. Proper operation is within the green range (12V-15V). A reading in the red region (15V-16V) is evidence that the charging circuit is experiencing an excessive amount of resistance in performing its task (such as that caused by dirty battery posts, loose connections, or a "sulphated" battery). With the ignition switch "ON" but the engine not running, the volt meter will give a direct reading of battery charge in volts. This should be between 11 and 12 volts for a battery that is "up to charge". A reading of 10 volts while starting the engine is normal and should be no cause for alarm. Periodic observation of the volt meter should afford the operator advance knowledge of electrical problems in most cases.

PACKAJET 455 ENGINE MAINTENANCE CHART

MAINTENANCE SERVICE	MAINTENANCE INTERVAL (TIME IN HOURS)															
	10	50	100	150	200	250	300	350	400	450	500	550	600	650	700	750
Engine Oil Change Inspect for loose fittings, belts, clamps, hoses or bolts	X	X	X	X	X	X	X	X	X	X	X	X	X	X	X	X
Inspect for fuel, oil, or water leaks	EACH TIME THE BOAT IS USED															
Inspect fuel line	EACH TIME THE BOAT IS USED															
Lubricate starter gear and shaft	X	X	X	X	X	X	X	X	X	X	X	X	X	X	X	X
Lubricate universal joint	X	X	X	X	X	X	X	X	X	X	X	X	X	X	X	X
Engine Oil Filter - Replace	X	X	X		X		X		X		X		X		X	
Crankcase Ventilation Filter			X		X		X		X		X		X		X	
Crankcase Ventilation Valve - Replace			X		X		X		X		X		X		X	
Carburetor Fuel Filter - Replace			X		X		X		X		X		X		X	
Battery and Terminals - Clean			X		X		X		X		X		X		X	
Flame Arrester			X		X		X		X		X		X		X	
Engine Tune-up			X		X		X		X		X		X		X	

It is recommended that after the first ten hours of running time that the engine cylinder heads be re-torqued to 80 Lb. Ft. using a suitable torque wrench and following the tightening sequence pictured below.

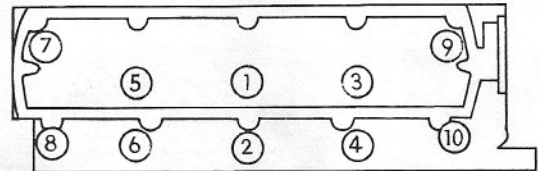

Figure 12

IV. MAINTENANCE

A. ENGINE FLUSHING PROCEDURE If a fresh water cooling system is not employed on the engine, a thorough flushing of the engine's cooling system should be performed after operation of the boat, however brief, in salt water. Neglecting to do so will cause restriction and eventually blockage of the engine's water passages caused by the accelerated oxidation resulting from the presence of salt compounds.

Simply remove the water inlet hose and supply fresh water to the engine through a garden hose (Figure 13). Open the faucet to full flow, start the engine and allow it to run for approximately five minutes or until the discharge water emitted from the exhaust outlets bears no traces of a salty taste.

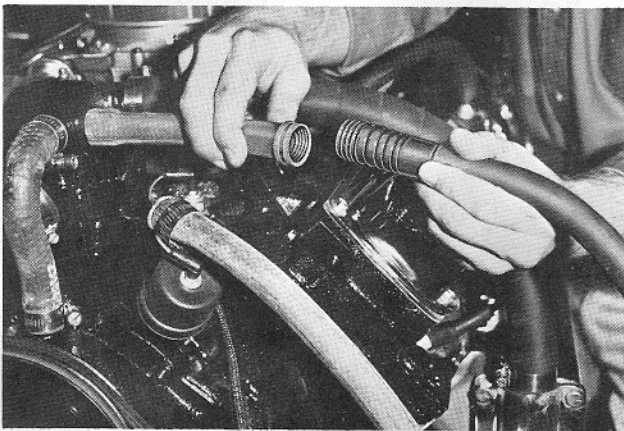

Figure 13

This will thoroughly flush the upper areas of the engine, including the intake manifold and cylinder heads.

To keep salt deposits from building up in the exhaust risers and lower engine block, supplemental steps should be intermittently added to the flushing procedure. Turn off the engine, remove the riser drain plugs or open drain cocks (Figure 14) and restart the engine, allowing it to run until the water exiting the risers has no salty taste. It is recommended that steps also be taken to flush the lower part of the engine block.

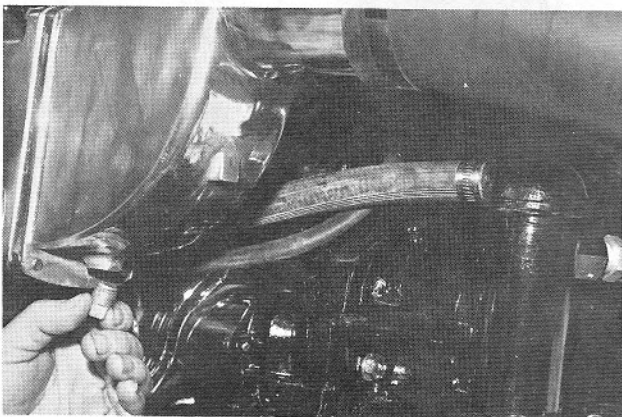

Figure 14

Turn off the engine, reinstall the riser drain plugs or drain cocks, remove one drain plug or drain cock on each side of the engine block (Figure 15), restart the engine and repeat the flushing operation. (Caution: At no time should the water temperature gauge reading exceed 170° F.). During the above two operations the temperature of the exhaust hoses should be closely watched to make sure the hose temperature does not increase to the point that the hoses become too hot to touch. Should the water temperature increase above 170° F. while flushing with the engine drain plugs or drain cocks removed, reinstall one drain plug or drain cock.

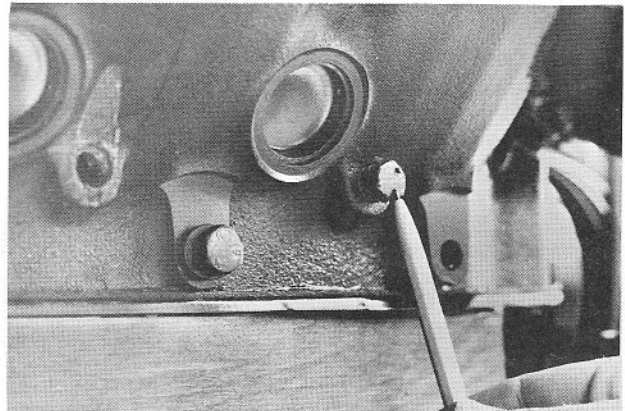

Figure 15

If the engine is equipped with an oil cooler (Figure 16) the procedure is the same, but it must be made absolutely certain that the cooler is also flushed. As with the engine oil cooler, the heat exchanger of a closed circulation system must always be flushed each time the boat is used in salt water.

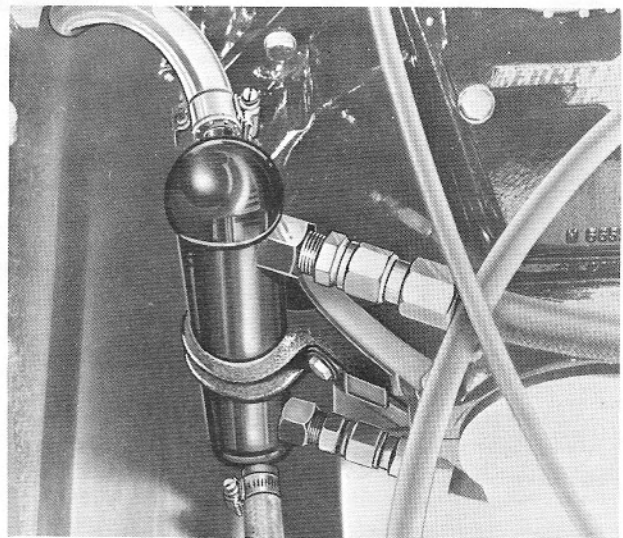

Figure 16

Observe the water temperature gauge to make certain that a sufficient amount of flushing water is being supplied at all times.

B. ENGINE OIL To keep the internal parts of the engine clean and free of sludge build-up and to allow the engine the best possible lubrication, regular oil changes must be made and the proper grade of oil used. Use only an engine oil meeting the Factory standard GM 6136 M SAE 30 viscosity, SE grade. Use of supplemental engine oil additives is specifically not recommended with the exception of those solely offered by G. M. dealers (such as G. M. High Detergent Concentrate) for a specific purpose. After the first 10 hours of operation, the oil and filter should be changed. Subsequently, the oil should be changed after every 50 hours of operation and the oil filter replaced at the time of every other oil change. Crankcase capacity of the engine is 4 U. S. quarts, 5 quarts when the filter is changed.

DRAINING PROCEDURE There are four basic methods which can be used for draining or removing oil from the engine's crankcase.

METHOD A Remove oil through pan drain plug.

1. Start engine and operate until normal operating temperature is attained, then shut off engine.
2. Remove oil drain plug located in engine crankcase pan and drain the oil.
3. At every other oil change replace oil filter.
4. Coat seal on face of new filter with motor oil. Install new filter and tighten $\frac{2}{3}$ turn past finger tight.
5. Replace drain plug.
6. Add oil, start engine and check for oil leaks.

METHOD B Remove oil through level indicator tube.

1. Start engine and operate until normal operating temperature is attained, then shut off engine.
2. Remove oil level indicator.
3. Insert hose into oil level indicator tube (Figure 17). Remove oil in crankcase by applying suction to tube either manually or with an electric pump.



Figure 17

4. Perform steps 3 and 4 of Method "A".
5. Install oil level indicator.
6. Add oil, start engine and check for oil leaks.

METHOD C Remove oil through distributor drive hole.

1. Start engine and operate until normal operating temperature is attained, then shut off engine.
2. Disconnect distributor wire from coil.
3. Remove distributor cap.
4. Remove vacuum hose from vacuum advance unit of distributor.
5. Mark position of distributor casting in relation to engine block by marking base of distributor at any convenient point and marking block in line with mark on distributor (Figure 18).

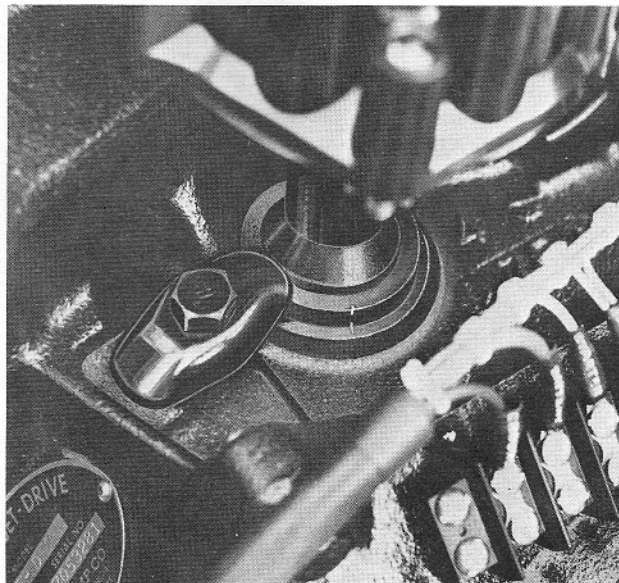

Figure 18

6. Note position of rotor in relation to distributor housing. Mark this location on edge of housing (Figure 19).

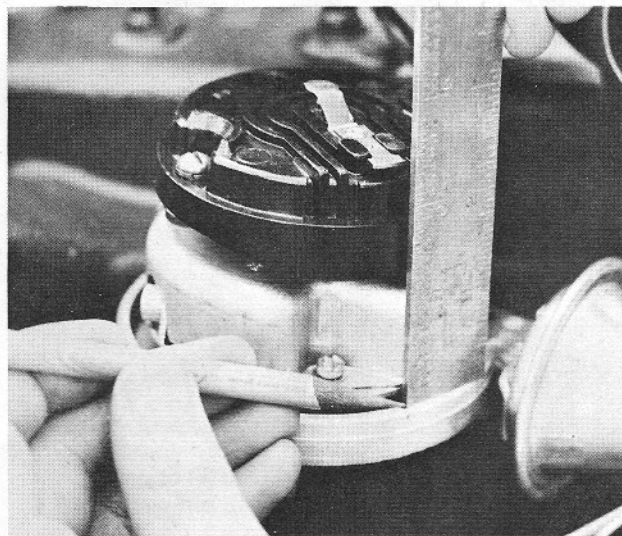

Figure 19

7. Remove distributor clamp screw and hold-down clamp. Pull distributor straight up and out of engine. Note: Care should be taken to assure that the engine is not "cranked over"

or rotated while the distributor is out of the engine. Because of the helical drive gear on the distributor shaft, the shaft will rotate counterclockwise approximately 35° when removed from the engine. This should be compensated for when reinstalling the distributor.

8. Insert hose into distributor drive hole. Remove oil in crankcase by applying suction to tube either manually or with an electric pump.
9. Perform steps 3 and 4 of Method "A".
10. Install distributor using reverse of procedure for removal. Start by inserting distributor shaft and housing into block and aligning distributor positioning marks (Part 5).
11. Add oil. Start engine, check for leaks. Note: If the engine has been rotated after the distributor was removed, it will be necessary to crank the engine until the saw slot in the harmonic balancer indexes with the zero timing mark on the engine front cover (Figure 20). If both valves of the No. 1 cylinder (first cylinder on the left hand side of the engine) are closed, the piston will be on top dead center (TDC) of the compression stroke, and the distributor can be installed with the rotor pointing to the No. 1 cylinder spark plug wire terminal in the distributor cap when the housing is seated in the block. To determine whether or not the No. 1 cylinder is on TDC of the compression stroke, remove the No. 1 spark plug from the cylinder head and place the thumb firmly over the spark plug hole. Now, crank the engine over until the timing marks on the harmonic balancer and engine front cover are properly aligned. If the No. 1 cylinder is in the firing position, TDC of the compression stroke, the cylinder pressure (approximately 130 PSI) will be readily noticeable.

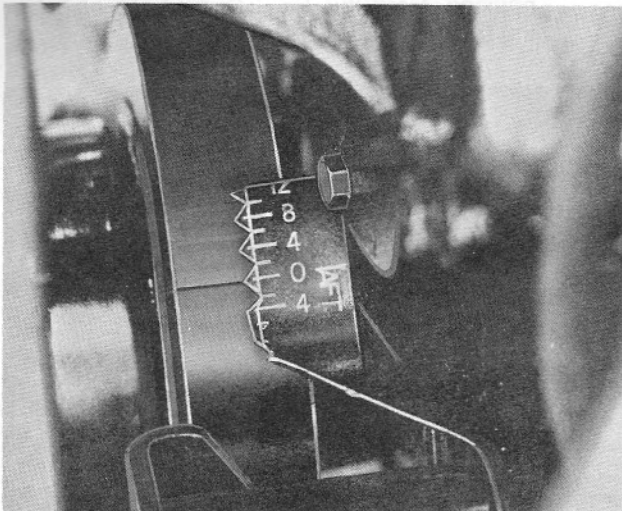

Figure 20

As stated previously, the engine oil filter should be changed after the first 10 hours of operation and at every other oil change thereafter. Use only G. M. Part No. 6437994 (AC Filter No. PF-30) or its equivalent.

All Model 455-2 Packajet engines are equipped with an external engine oil cooler located on the left side of the engine flywheel cover. The only maintenance operation that need be performed on the oil cooler is the flushing operation required after use in salt water. This has already been described at the beginning of this section.

METHOD D Remove oil through the oil pressure fitting at the front of the engine.

1. Start engine and run for approximately 10 minutes.
2. Remove oil pressure fitting from front L. H. side of engine.
3. Install 1/8"-27 threaded nipple 1" to 2" long in block.
4. Install rubber hose over nipple and lead end of hose into a 5-quart container.
5. Start engine and run at idle no more than 1,000 RPM maximum for 60 seconds, not longer. If indicated oil level in pan was 4 quarts at beginning of this procedure, 3 1/2 quarts will be evacuated during the 60 seconds of running.
6. Remove oil filter and replace filter element if change is due. Coat seal on face of new filter with new engine oil. Install new filter and tighten 2/3 turn past finger tight. Reinstall oil pressure fitting.
7. Install 3 or (4 if filter replaced) quarts of new SE rated 30W engine oil. Level on dipstick will be under full mark by a small amount. Add small amount of oil to bring to full, or operate engine normally until a full quart of make-up is required.

THIS PROCEDURE WILL NOT DAMAGE THE ENGINE IN ANY WAY, PROVIDED IT IS PERFORMED EXACTLY ACCORDING TO THESE INSTRUCTIONS.

C. BATTERY AND ELECTRICAL When installing or charging a battery or using jumper cables or a booster battery, extreme care must be exercised in attaching the proper cable to an individual battery post. Failure to do so could result in great damage to the alternator as well as the remainder of the electrical system. The Packajet 455 is equipped with either Oldsmobile's Delcotron alternator or a Motorola alternator, both of which contain a built-in, solid-state, transistorized voltage regulator.

D. CRANKCASE VENTILATION FILTER The crankcase ventilation filter is located in the center of the right hand valve cover (Figure 21). It should

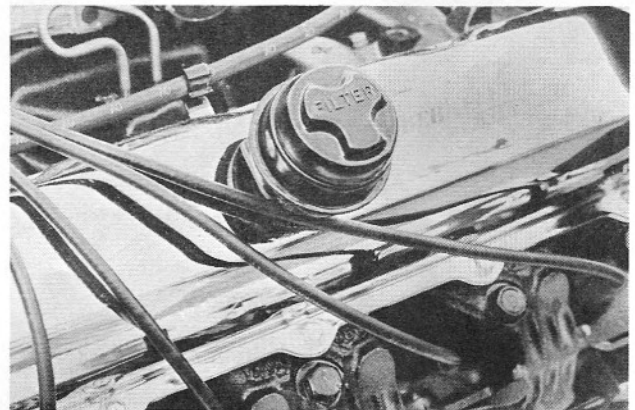

Figure 21

be removed, washed in kerosene, dried with compressed air and re-oiled at the time of every oil filter change.

E. CRANKCASE VENTILATION VALVE Once every 12 months the crankcase ventilation (P. C. V.) valve located in the opposite valve cover should be replaced and the remainder of this system cleaned as outlined above for the crankcase ventilation filter (Figure 22).

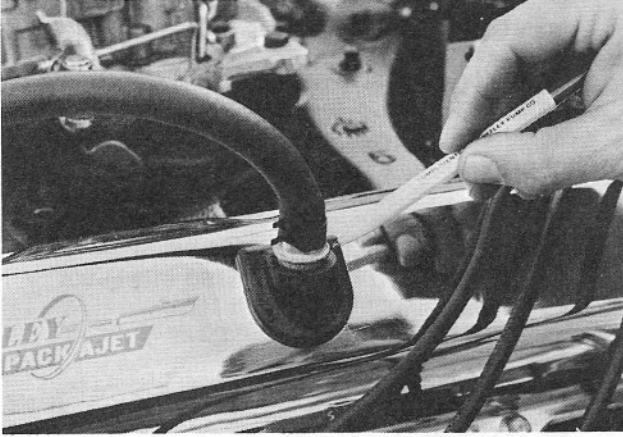

Figure 22

F. FUEL FILTER Located within the fuel line adapter fitting at the front of the carburetor is the fuel inlet filter (Figures 23, 24). It is of the paper element type and should be replaced once every 12 months.

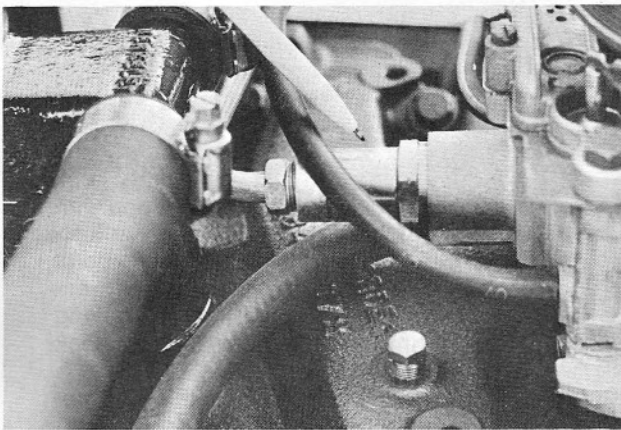

Figure 23

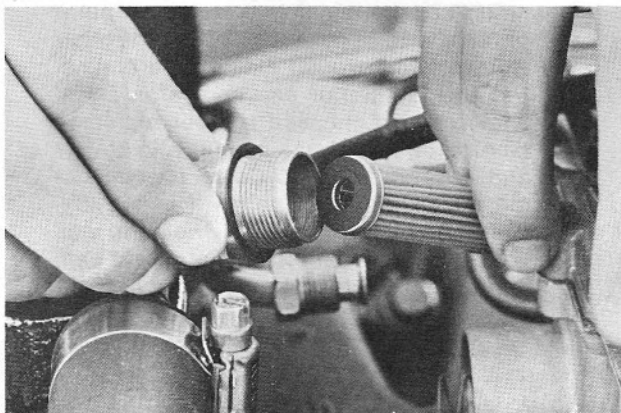

Figure 24

G. FLAME ARRESTER After every 100 hours of operation the flame arrester should be checked and cleaned.

H. WINTER LAY-UP When a boat is to be stored for the winter season, definite preparatory operations should be performed.

1. Completely flush the engine, including the exhaust risers and lower engine block. (See Engine Flushing Procedure.) Remember, when running the engine with the boat out of the water the lower portion of the Jet-Drive bowl must be filled with as much water as possible, and the water temperature gauge must be closely observed to assure that a sufficient water supply source is connected to the engine.
2. With the engine hot, change the crankcase oil and filter. (See Draining Procedure.) After the oil and filter change is completed, run the engine briefly to circulate the new oil throughout the engine.
3. Remove the flame arrester and start the engine, allowing it to idle. Very slowly pour the contents of one small can of top oil through the carburetor intake, leaving enough fluid in the can to just stall the engine out as the contents are depleted. Reinstall the flame arrester.
4. Drain all water from the risers, both sides of the engine block, and the oil cooler and heat exchanger, if so equipped.
5. Remove the battery from the boat and store it off the ground in a convenient location.
6. Lubricate the starter gear and shaft. (See Pre-Operation Check, Starter and Universal Joint Lubrication.)
7. Coat all electrical connections and bright metal parts with a light coat of rust preventative.
8. Cover the intake area of the flame arrester with tape. Plug the exhaust ports with rags or tape them closed.

PREPARATION FOR USE

1. Clean all electrical connections and bright metal parts. If any electrical connections show signs of corrosion, clean them with steel wool and apply a thin coat of petroleum jelly to preclude further contamination.
2. Install a fully charged battery with clean battery posts. Ground the negative terminal.
3. Remove the tape from the flame arrester and unplug the exhaust ports.
4. Perform the Pre-Operation Check as outlined in the Operation Section of this manual.
5. Perform general maintenance or tune-up operations as required.
6. Before starting the engine remove all spark plugs and turn the engine over by hand to ensure that all reciprocating parts are free.
7. When first starting the engine a certain amount of cranking may be necessary to allow the fuel pump to fill the carburetor's float bowl.
8. Review the Starting Procedure. (See Operation Section.) As soon as the engine starts check the oil pressure gauge. The reading should not be less than 35 PSI at idle when the engine is cold. Check for oil, fuel or water leaks and listen for any abnormal noises.

V. TUNE-UP

Some of the tune-up procedures listed below will be performed while the engine is running. An adequate supply of water must be available for engine cooling and pump cooling and lubrication. Refer to Section 11 "Operation", paragraph F, "Starting", for instructions for running the engine when boat is not in the water.

RECOMMENDED OPERATIONS

Once a year or every 100 hours, whichever occurs first, it is recommended that a general tune-up be performed.

PROCEDURE

1. COMPRESSION TEST

- A. Start engine and allow to warm up. Turn off engine and remove air cleaner and all spark plugs. (See 2A below.)
- B. Remove coil secondary lead from center of distributor cap and attach to jumper wire leading to ground.
- C. Make sure that choke valve is wide open; also block or hold throttle open completely.
- D. Run test using a good quality compression gauge. Compression should build up to a maximum of 120 to 140 PSI in no more than five compression strokes (ten engine revolutions). A higher than normal reading indicates a build-up of carbon deposits. A reading of 170 PSI or more will require that these deposits be removed. Make notation of each maximum reading. Note: If using a remote (hand held) starter switch, make certain that the ignition switch is in the "ON" position. Otherwise, the ground contact in the switch and/or the ignition contact in the starter solenoid may be irreparably damaged.

2. SPARK PLUGS

- A. Before removing plugs, clean cylinder head area adjacent to spark plug seat. Removal of foreign matter in this region prevents its entering cylinder or causing spark plug threads in head to become fouled.
- B. If old plugs are to be reused, clean exterior of each plug completely. Remove any traces of oil, dirt or paint. Rust or corrosion on plug terminal should be removed with steel wool. The presence of contamination here suggests same condition exists on internal surfaces of corresponding plug wire terminal, which must also be cleaned.
- C. Interior area of each plug must be cleaned with abrasive type spark plug cleaner and both electrode surfaces filed until flat. (Note: New plugs should not be filed.) Gap plugs according to "Specifications" and check with spark plug tester using compressed air and applied voltage. If any cracks in porcelain "nose" of plug exist, they will be easily noticed at this time. No plug should exhibit any difficulty firing at cylinder pressure attained during compression test.
- D. Install plugs and tighten to 25 lb. ft. torque. When torque wrench is not available, tighten until snug; from this point tighten only a reasonable amount.

3. SPARK PLUG WIRES

- A. If it is desired to reuse spark plug wires, resistance of each spark plug wire and also ignition coil secondary lead must be checked with an ohmmeter.
- B. Maximum permissible resistance for spark plug wires and/or coil wire under two feet in length is 25,000 OHMS, whereas maximum resistance for wires over two feet in length is 50,000 OHMS.
- C. Those wires having a resistance within prescribed range may be reused; all others must be replaced.

4. DISTRIBUTOR CONTACT POINTS AND CONDENSER

- A. Inspect for excessive burning and/or pitting of points. Replace if necessary. Note: When installing new points, remove any oxidation or film from the surface of the points with acetone or carbon tetrachloride before starting the engine. This will avert any premature burning of the points.
- B. Apply thin film of ball bearing lube or its equivalent to distributor cam.
- C. When replacing points, condenser should be replaced at same time unless it is possible to check its capacitance (0.18-0.25 μ F). If facilities are available to make this test and condenser falls within acceptable range, it may be reinstalled. Otherwise, replace it.
- D. Contact point adjustment should be made with a feeler gauge and checked with a dwell meter, if possible.
 1. Feeler gauge method. Remove distributor cap and rotor. Rotate distributor cam by slightly actuating starter switch until wear block on points' breaker arm is resting on highest point of distributor cam. (Note: The distributor shaft can be partially turned in a counterclockwise [CCW] direction, so it is not necessary to have the wear block come to rest on the very peak of the cam.) Check contact point gap with a clean 0.020 in. feeler gauge. If adjustment is necessary, loosen contact point locking screw and adjust points with eccentric adjustment screw (in elongated hole). Tighten locking screw and re-check gap with feeler gauge.
 2. Dwell Angle Method. (This is the most accurate means of making the adjustment.) Calibrate dwell meter to the "Set Line" for 4 and 8 cylinder engines. Attach one lead of meter to negative (-) side of ignition coil (terminal to which distributor primary lead is connected). Secure other lead to good ground location on engine. Remove distributor cap and rotor. Dwell angle can be checked without replacing distributor cap. Crank engine with starter and observe reading. Correct dwell angle is 30°. Readjust points if necessary. (Decrease gap to increase dwell and vice versa.) Replace distributor rotor and cap, start engine and make final dwell angle check.

5. DISTRIBUTOR CAP AND ROTOR

- A. Remove cap and inspect center (coil) electrode. It should have the appearance of a small rubber cone or hemisphere.
- B. Any severe burning or corrosion of spark plug terminals within cap will require that cap be replaced.
- C. Check for cracks in cap and/or rotor by inspecting both for signs of carbon tracking (thin, irregular lines of fine carbon particles). Cracks or chips in the cap or rotor will make replacement mandatory.
- D. Spring contact of distributor rotor should be securely attached to rotor blade and have sufficient tension to allow good contact with center electrode of distributor cap. Failure to meet these requirements will dictate replacement of the rotor as will signs of corrosion or excessive burning on the rotor blade tip or spring contact disc.

6. IGNITION TIMING

With the point dwell or gap adjusted, the initial timing of the distributor can be accomplished.

- A. Disconnect and plug vacuum hose leading to vacuum advance unit on distributor (Figure 25).

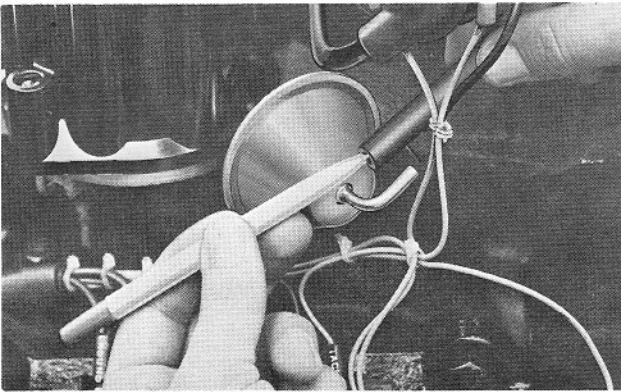

Figure 25

- B. Attach leads of timing light to spark plug lead of No. 1 cylinder (front cylinder on left bank of engine) and to power source, if required (Figure 26).

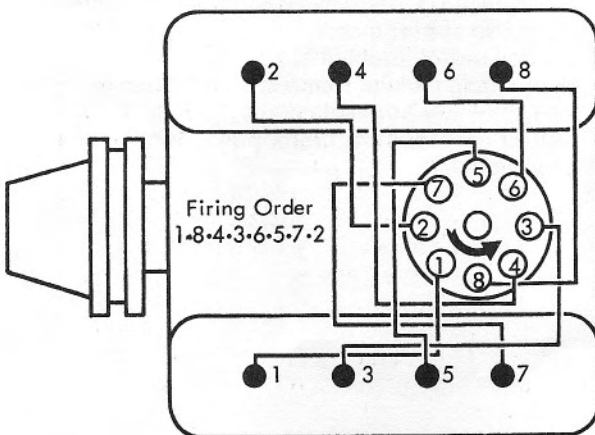

Figure 26

- C. Start engine and allow to idle. Set idle speed to that specified for ignition timing. (See Engine Specifications, page 19.) Turn adjustment screw clockwise (CW) to increase idle speed (Figure 27).

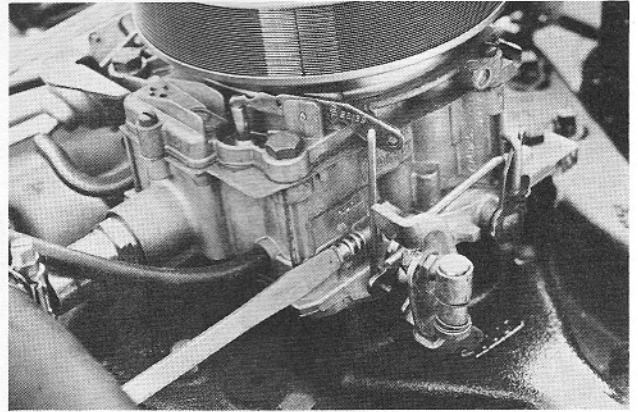

Figure 27

- D. Loosen distributor hold-down clamp screw.
- E. Direct timing light flash at engine's harmonic balancer and timing tab on engine's front cover. Rotate distributor housing until slot on harmonic balancer aligns with proper location on timing tab as given by timing specification.
- F. Tighten distributor hold-down clamp screw and recheck timing. Remove plug from vacuum advance hose and reinstall hose.

7. CARBURETOR

- A. Remove fuel inlet nut, gasket and filter (Figure 23).
- B. Thoroughly clean out filter cavity using compressed air. Note: Be alert for the presence and nature of any residue present in the fuel filter cavity. Grey deposits indicate internal corrosion of the fuel pump caused by water in the fuel; red deposits suggest fuel line corrosion due to the same cause.
- C. Discard old gasoline filter and install new one, positioning it against compression spring. Note: Make certain that gasket end of filter element is facing out of the carburetor body (Figure 24).
- D. Install fuel inlet nut and gasket.
- E. Start engine and allow to warm up. Turn off engine and remove flame arrester. Disconnect and plug vacuum advance hose from distributor. Choke should be fully open and cam follower off steps of fast idle cam.
- F. Readjust idle speed to 850 RPM using idle speed screw.
- G. As a starting point for adjusting idle mixture, turn adjustment screws clockwise until light contact of screw against seat is felt. (Caution: If mixture screws are turned tightly against their seats, damage will result.) Now turn screws counterclockwise two turns.
- H. Final adjustment can be made with either tachometer or vacuum gauge; highest attainable reading of either instrument at idle is setting desired. Adjustment should be made in 1/4 turn increments in either direction.
- I. Unplug vacuum hose and reinstall.

J. Once again, readjust idle speed to 850 RPM using idle speed screw.

The Packajet 455 has been designed and manufactured to perform flawlessly. Every effort has been expended to ensure your complete satisfaction. In spite of these facts, however, minor difficulties can occur. Even in the most refined systems of aerospace technology, trouble shooting is an integral part of the operational program. The following ignition and carburetor diagnosis charts and suggestions for more general areas will provide you with the information necessary to pinpoint any problem that should arise. They have been reprinted (and modified in part to comply with the Packajet wiring system) by permission of Oldsmobile Division, General Motors Corporation.

VI. TROUBLE SHOOTING

GAS MILEAGE

1. Distributor points burned or misadjusted.
2. Incorrect dwell and ignition timing.
3. Low engine vacuum.
4. Spark plugs fouled.
5. Plugged flame arrester.
6. Driver's habits.
7. Closed or partially closed choke.
8. Plugged positive crankcase ventilation system.
9. Incorrect air/fuel ratio at 1500 RPM test.
10. Black smoke at exhaust outlet shows rich gas mixture.
11. High or misaligned floats.
12. High fuel pump pressure.
13. Stuck power piston or wrong size in metering jets.

HARD START COLD

1. Low battery.
2. Choke stuck open.
3. Loose coil or ignition wires.
4. Distributor points burned or misadjusted.
5. Flooding condition.
6. Spark plugs fouled.
7. Lack of fuel at carburetor.
8. Weak or shorted coil.
9. Starter drawing excessive amperage.
10. Battery cables loose or corroded.
11. Shorted distributor condenser.
12. Low compression.
13. Ignition switch problems.
14. Carburetor unloader misadjusted.
15. Foreign material or water in fuel system.

HIGH SPEED PERFORMANCE

1. Distributor points or incorrect dwell and ignition timing.
2. Spark plugs fouled, incorrect gap or heat range.
3. Stuck power valve or piston.
4. Closed or partially closed choke.
5. Foreign material or water in fuel.
6. Lack of fuel at carburetor.
7. Low fuel pump pressure.
8. Restricted high speed jets, low floats.
9. Burned or sticky valves, weak or broken springs.
10. Worn or seized piston rings.

11. Vapor lock.
12. Excessive carbon in heads.
13. Restricted exhaust system.
14. Plugged flame arrester.
15. Insufficient vacuum advance.
16. Weak or shorted coil or condenser.
17. Retarded valve timing.
18. High engine oil pump pressure.

ENGINE WILL CRANK BUT WON'T START

1. Weak or shorted coil, no spark at plugs.
2. Distributor points misadjusted or burned, or shorted condenser.
3. Lack of fuel at carburetor.
4. Low battery.
5. Starter drawing excessive amperage.
6. Low compression.
7. Retarded or advanced valve timing.

IDLE — MISSES OR ROUGH

1. Spark plugs fouled or cracked.
2. Spark plug or distributor wires loose or shorted.
3. Plugged positive crankcase ventilation system.
4. Vacuum leak.
5. Plugged idle jets or improperly adjusted idle screws.
6. Weak or shorted coil.
7. Distributor points burned.
8. Burned or sticky valves, weak or broken springs.
9. Leaky head gaskets.
10. High fuel pump pressure.
11. Worn cam lobe.
12. Carburetor icing.

HARD START HOT

1. Flooding condition.
2. Distributor points burned or misadjusted.
3. Closed choke.
4. Plugged flame arrester.
5. Spark plugs fouled.
6. Low compression.
7. Weak or shorted coil.
8. Loose coil or ignition wires.
9. Battery cables loose or corroded.
10. Low battery.
11. Starter drawing excessive amperage.

ENGINE WON'T CRANK

1. Low battery and loose or corroded cables.
2. Misadjusted or defective neutral safety switch.
3. Defective starter motor.
4. Ignition switch problems.
5. Hydrostatic lockup. Remove spark plugs to look for water or gasoline in cylinders.
6. Seized engine. Turn crank pulley with socket and ratchet.

IGNITION SYSTEM DIAGNOSIS

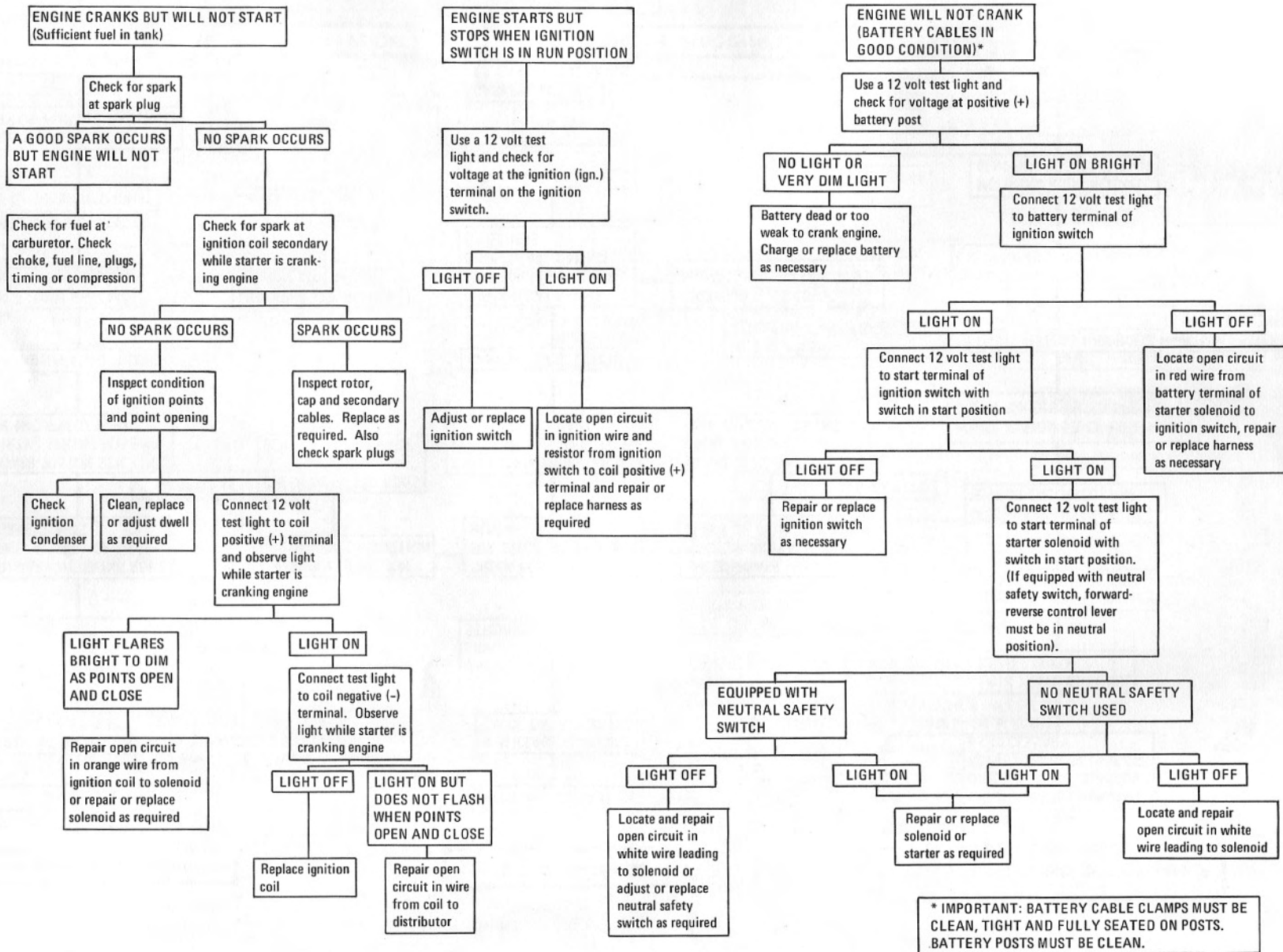

CARBURETOR DIAGNOSIS CHART

ENGINE RUNS ROUGH, SURGES

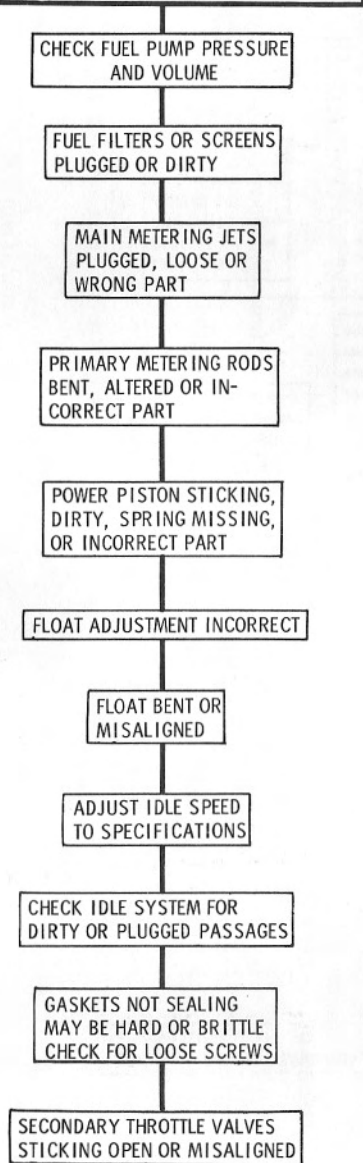

POOR GAS MILEAGE

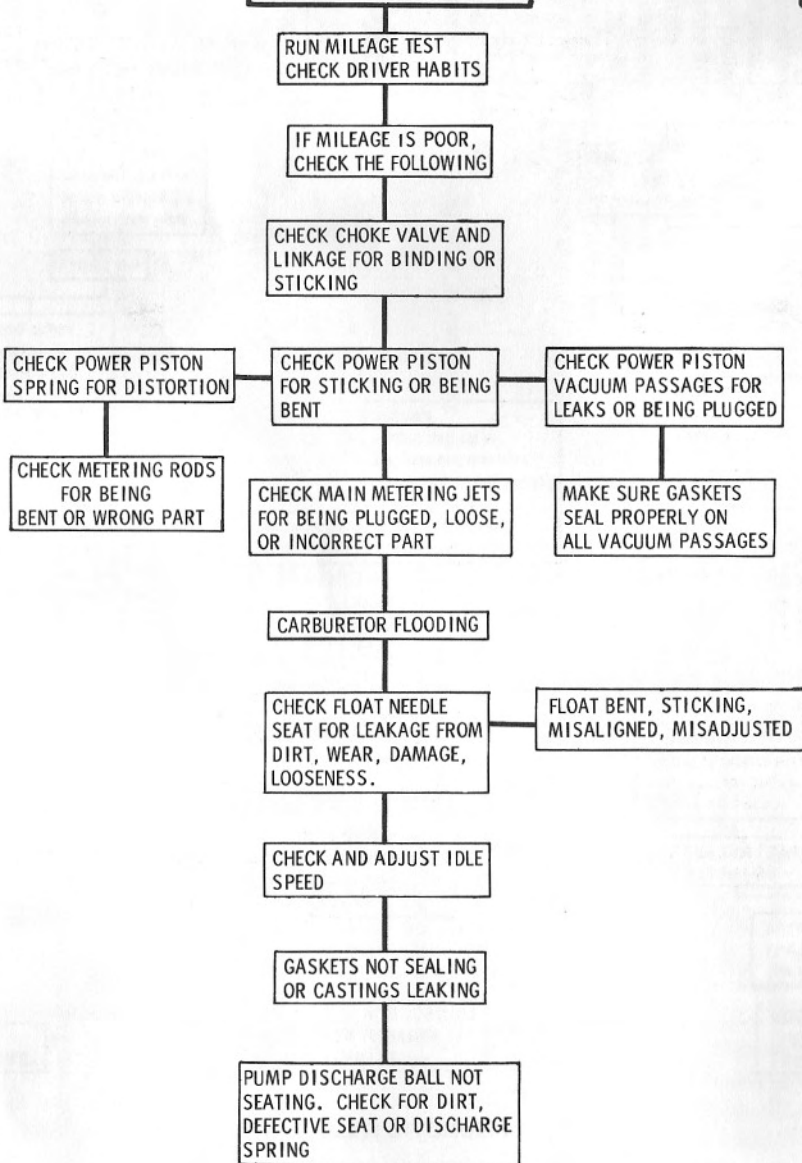

POOR HIGH SPEED PERFORMANCE

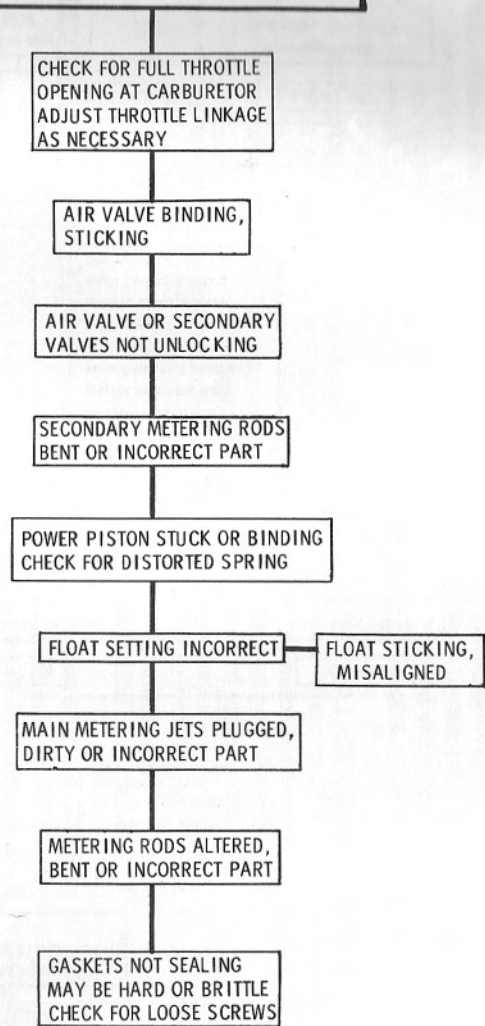

CARBURETOR DIAGNOSIS CHART

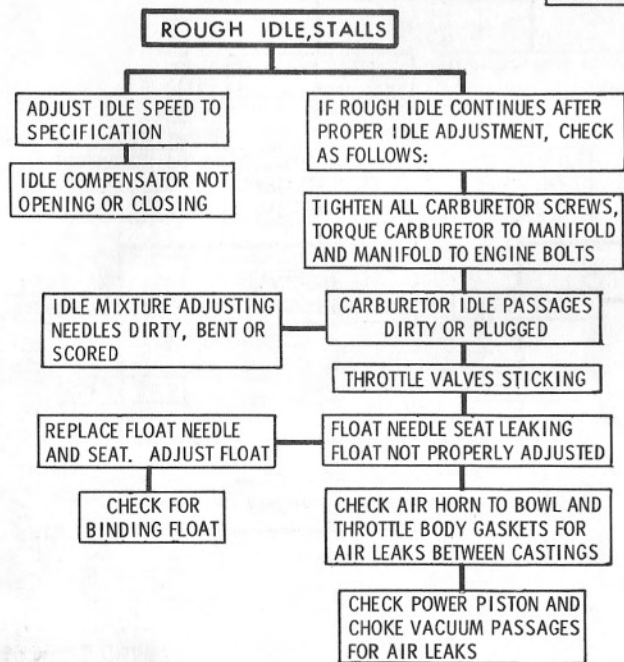
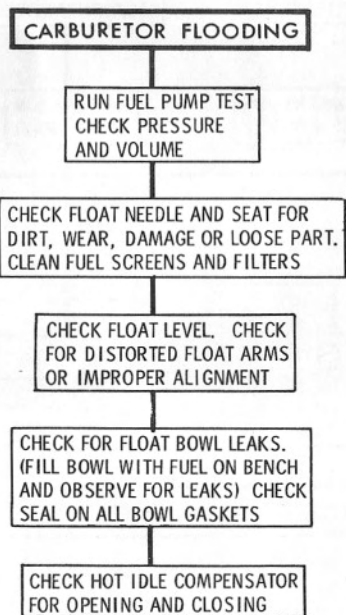
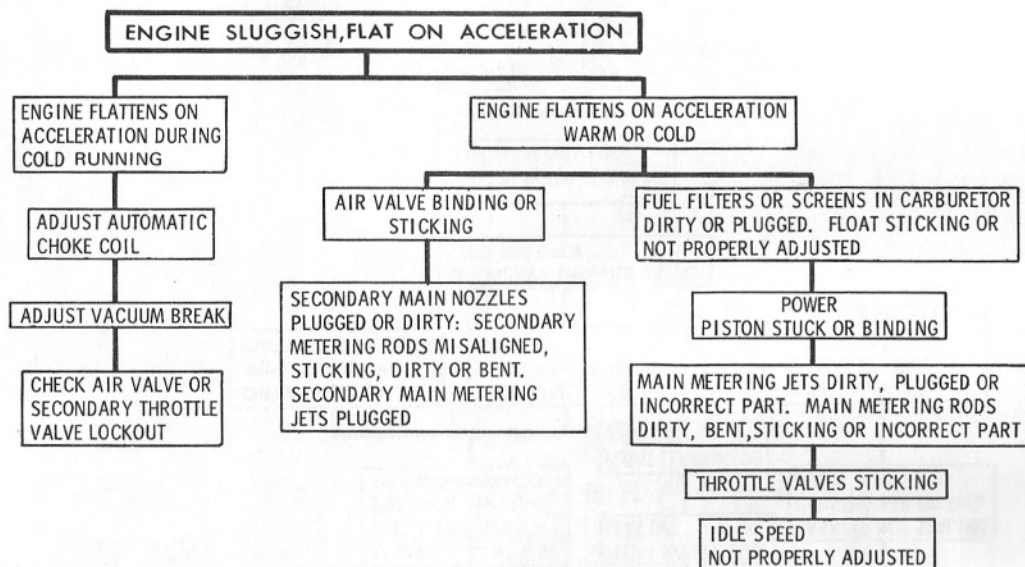
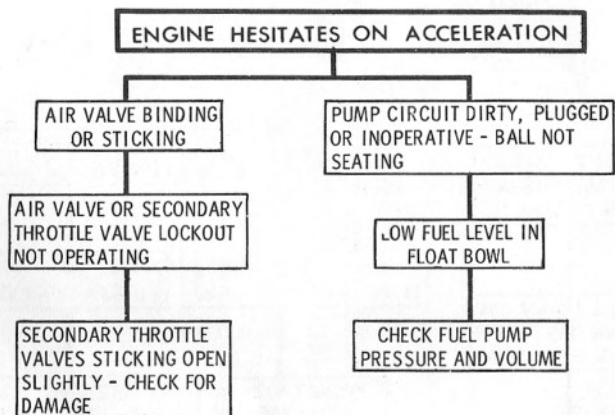

SPECIFICATIONS

PACKAJET 455

	455-4	455-3	455-2
HORSEPOWER	320 at 4800 RPM	295 at 4500 RPM	330 at 4700 RPM
COMPRESSION RATIO	8.5 to 1	8.5 to 1	10.25 to 1
MIN. FUEL REQUIREMENT	REGULAR	REGULAR	PREMIUM ONLY
DISTRIBUTOR TIMING	10° at 1100 RPM	14° at 1100 RPM	12° 1100 RPM
FULL ADVANCE	30° at 2800 RPM AND ABOVE	28° at 3000 RPM	22° at 3000 RPM
SPARK PLUGS	A.C. R46S	A.C. R46S	A.C. R44S
SPARK PLUG GAP SETTING	.040 IN.	.040 IN.	.030 IN.
DISPLACEMENT		455 CU. IN.	
BORE AND STROKE		4.125 IN. X 4.250 IN.	
SHIPPING WEIGHT		825 LB.	
CRANKCASE CAPACITY		4 QTS. (U.S.), 5 QTS. (U.S.), WITH FILTER	
OIL PRESSURE		30-45 PSI at 1500 RPM	
OIL FILTER ELEMENT		A.C. PF-30 OR EQUIVALENT	
CARBURETOR		4BBL	
FUEL FILTER		PLEATED PAPER ELEMENT IN CARBURETOR	
		A.C. GF-441 OR EQUIVALENT	
FUEL PUMP		DUAL-DIAPHRAGM MARINE TYPE A.C. 40800	
CONTACT POINTS DWELL ANGLE		MALLORY 30°	41567
CONTACT POINT SET		MALLORY 25042	
CONDENSER		MALLORY 400	
DISTRIBUTOR CAP		MALLORY 209-B-209D	
ROTOR		MALLORY 309	
TIMING MARK LOCATION		HARMONIC BALANCER	
SPARK PLUG CABLES		DELCO 468S OR EQUIVALENT	
FIRING ORDER		1-8-4-3-6-5-7-2.	
RECOMMENDED BATTERY		12 VOLT—90 PLATE—74 AMPERE HOURS	
TERMINAL GROUND		NEGATIVE	
THERMOSTAT SETTING			
RAW SALT WATER COOLING		143°	
RAW FRESH WATER COOLING		160°	
CLOSED COOLING		195°	
FAN BELT		DAYCO #18 (15415) OR EQUIVALENT	
P.C.V. VALVE		A.C. CV679C OR EQUIVALENT	FRAM FV112
VENTILATION FILTER		A.C. FB-55 OR EQUIVALENT	

DISTRIBUTOR MALLORY YLSD16V

Mallory e-spark 61004M

PACKAJET IGNITION AND GAGE WIRING

L-4080

DELCO ALTERNATOR

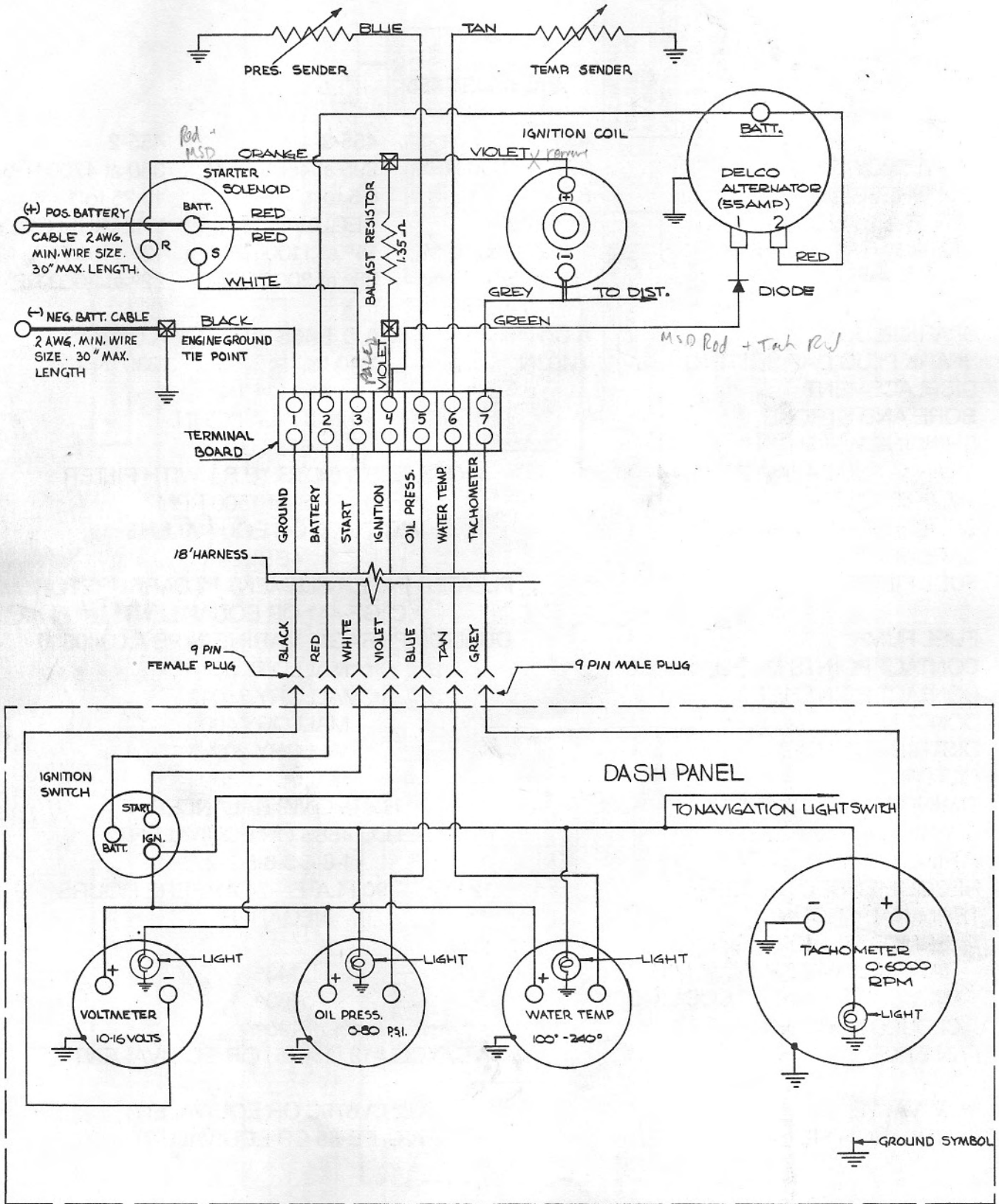

STEWART-WARNER

L-4080

PACKAJET IGNITION AND GAGE WIRING

L-4913

MOTOROLA ALTERNATOR

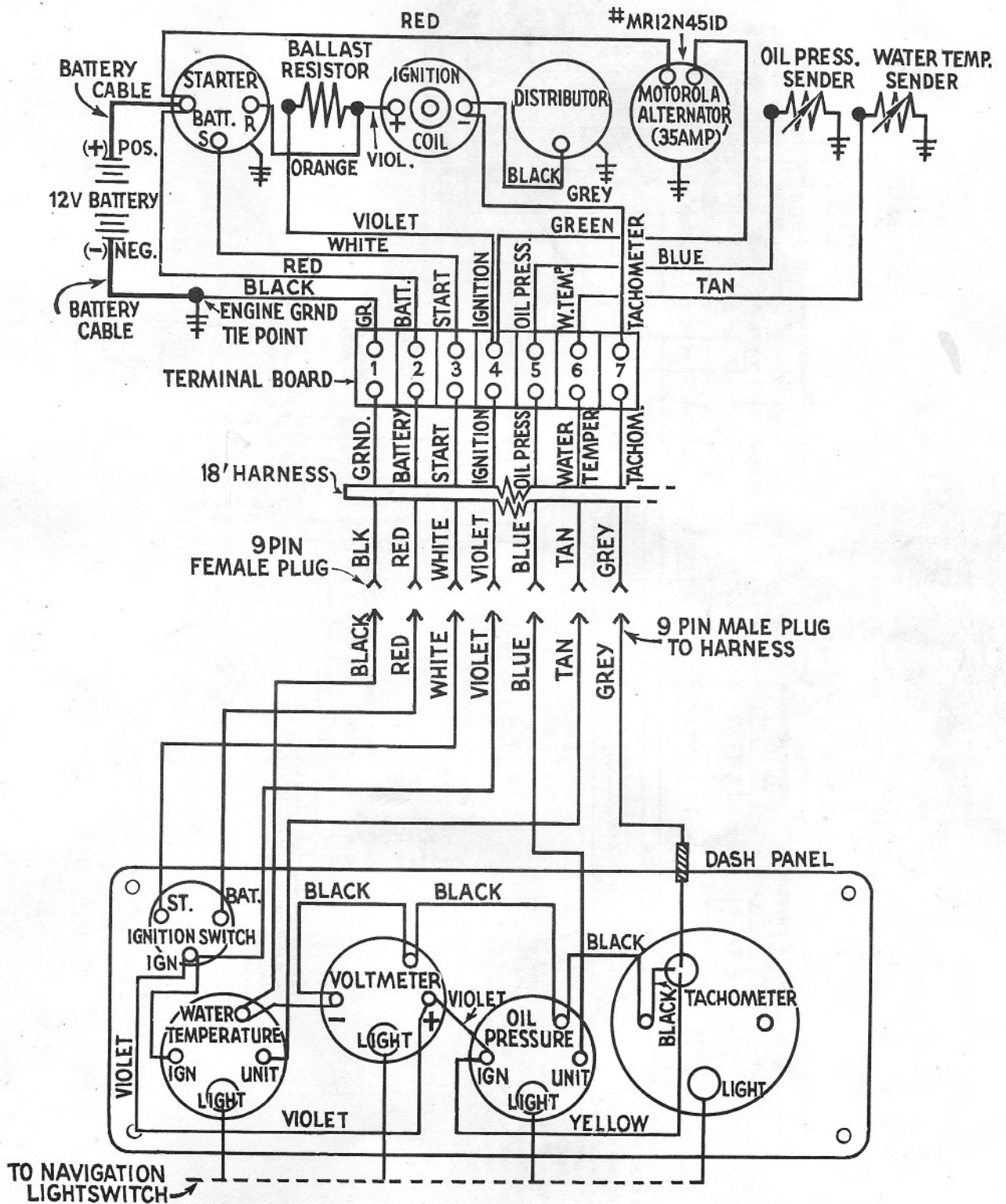

AMERICAN YAZAKI

L-4870

American Yazaki and Stewart-Warner panels or clusters may be interchanged as a unit.

PACKAJET ACCESSORY WIRING

L-4279

NOTE: - ALL ACCESSORIES DESIGNED TO OPERATE INDEPENDENT OF THE IGNITION SWITCH MAY BE CONNECTED TO THE BATT. (+) POST AND THE GROUND (-) POST OF THE FUSE BLOCK.

- BROKEN LINE (---) INDICATES EQUIPMENT NOT SUPPLIED WITH BERKELEY ACCESSORY PANEL PACKAGE.

- INSTRUMENTS SUCH AS HOUR METER & FUEL GAUGE MUST BE CONNECTED THROUGH IGNITION SWITCH ON INSTRUMENT HARNESS.

