

Top View

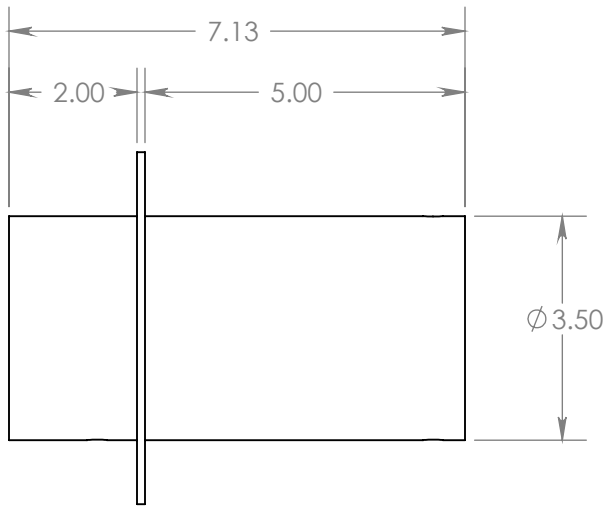

Side View

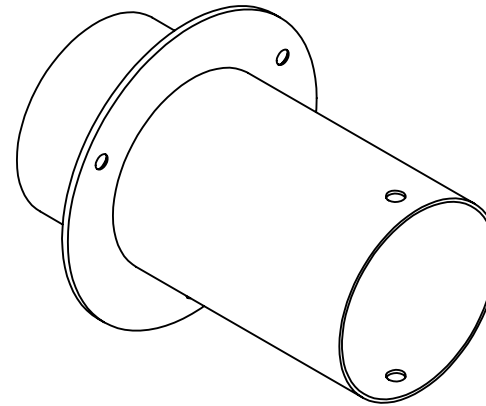
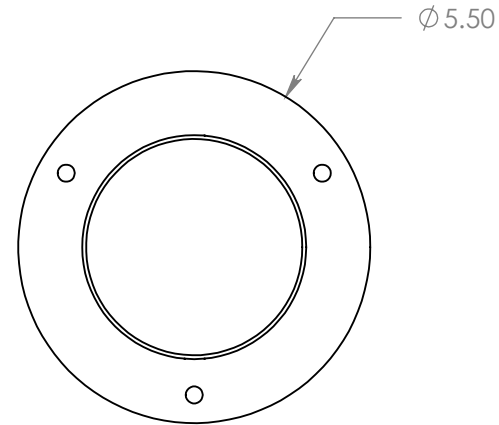

Rear View

UNLESS OTHERWISE SPECIFIED
DIMENSIONS ARE IN INCHES.
TOLERANCES ARE:

DECIMALS

.XXX ±.005

ANGLES

.XX ±1°

MATERIAL

S/S

DATE

8/22/11

FINISH

Polished

DRAWN

RT

IMCO

3 1/2" STRAIGHT CUT

DWG. NO.

02-6298

REV.

A

CAD FILE:

02-6298

SHEET 1 OF 1